

HL63290HD

638nm / 2.2W (CW) / 2.8W (Pulse)

AlGaInP Laser Diode

Outline

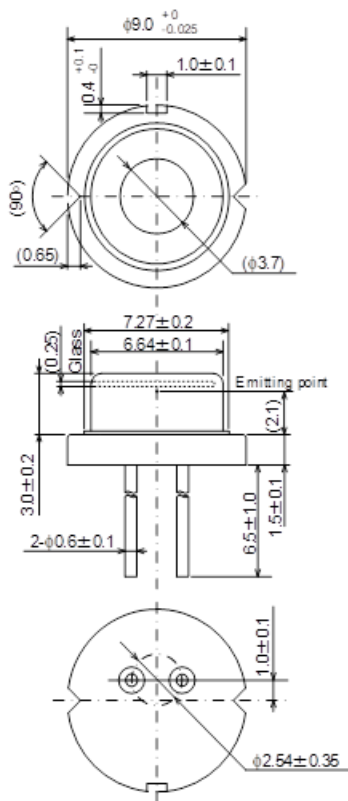

(Unit: mm)

Internal Circuit

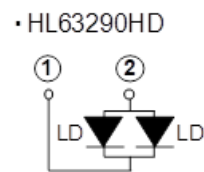

Features

- Dual emitters
- Optical output power: 2.2W (CW)
2.8W (Pulse)
- Shorter wavelength: 638nm Typ.
- High heat dissipation $\phi 9$ mm CAN package
- Multi transverse mode
- TM mode oscillation

Application

- Laser Projector
- Light source of optical equipments

Absolute Maximum Ratings (Tc=25°C)

Item	Symbol	Ratings	Unit
Operating current ^{Note1)}	Iop	2.4	A
Pulse operating current ^{Note1) Note2)}	Iop(Pulse)	2.8	A
LD reverse voltage	VR(LD)	2	V
Operating temperature ^{Note1) Note3)}	Topr	-10 ~ +55	°C
Storage temperature	Tstg	-40 ~ +85	°C

Note1) The relation of operating temperature vs operating current and typical optical output power are based on Fig.1, 2.

Note2) Pulse condition: Pulse frequency ≥ 120Hz, duty ≤ 30%

Note3) Operating temperature is defined by Case temperature “Tc”. High increase in temperature of LD chip itself is expected during operation due to high current density. Thus, without proper heat dissipation, it is observed that no specific output power is achieved or it results to LD degradation. It is advised that sufficient measure of heat dissipation should be taken so that LD’s maximum operating temperature is not exceeded during actual operation.

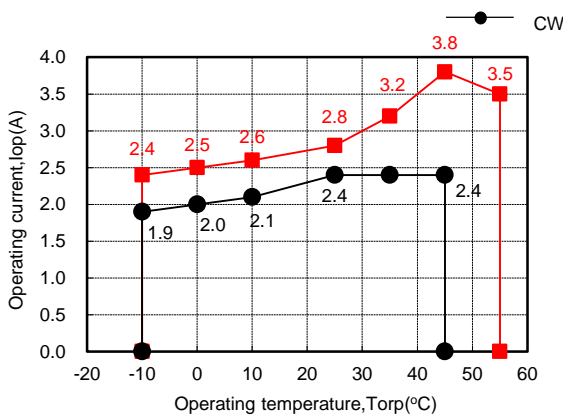

Fig.1 The relation of operating temperature vs maximum operating current

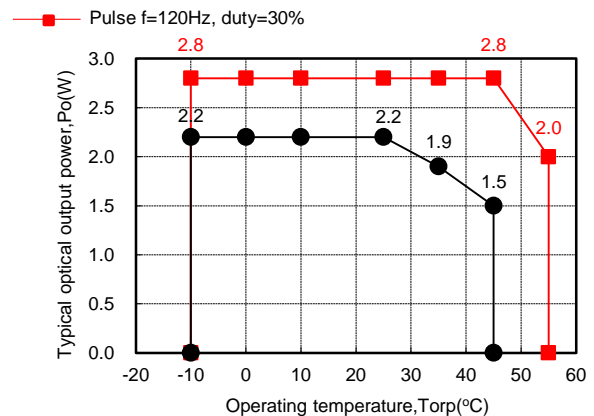

Fig.2 The relation of operating temperature vs optical output power

Optical and Electrical Characteristics (Tc=25°C)

Parameter	Symbol	Min	Typ	Max	Unit	Test Condition
Optical output power	Po	-	2.2	-	W	Iop=2.4A
Pulse optical output power	Po(Pulse)	-	2.8	-	W	Iop(Pulse)=2.8A, f=120Hz, duty=30%
Threshold current	Ith	-	600	750	mA	-
Operating voltage	Vop	-	2.4	2.8	V	Po=2W
Beam divergence ^{Note4)} Parallel to the junction	θ//	3	10	20	°	Po=2W, FWHM
Beam divergence ^{Note4)} Perpendicular to the junction	θ⊥	23	33	43	°	Po=2W, FWHM
Lasing Wavelength	λp	632	638	642	nm	Po=2W

Note4) Designed value

Typical Characteristic Curves

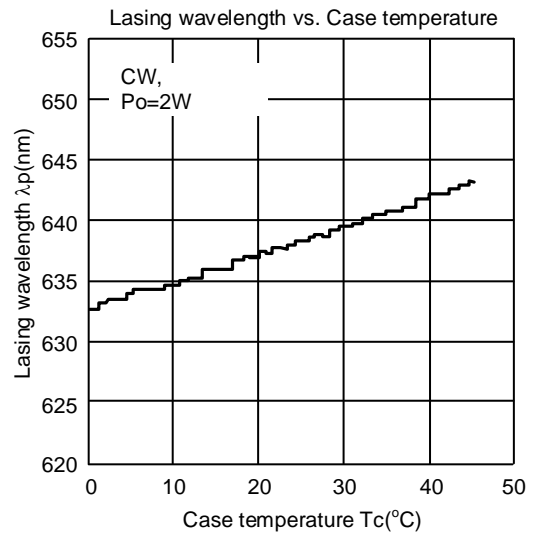
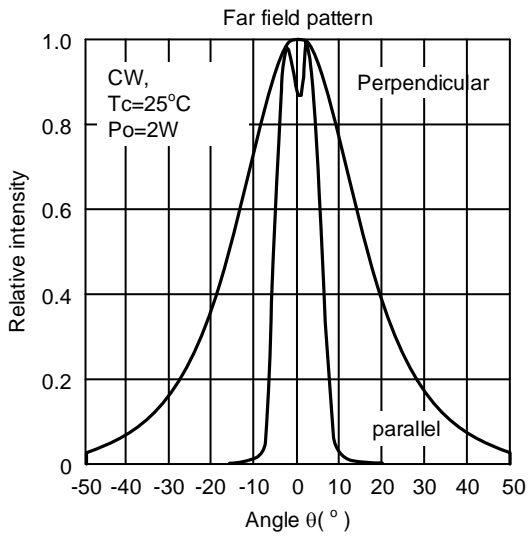
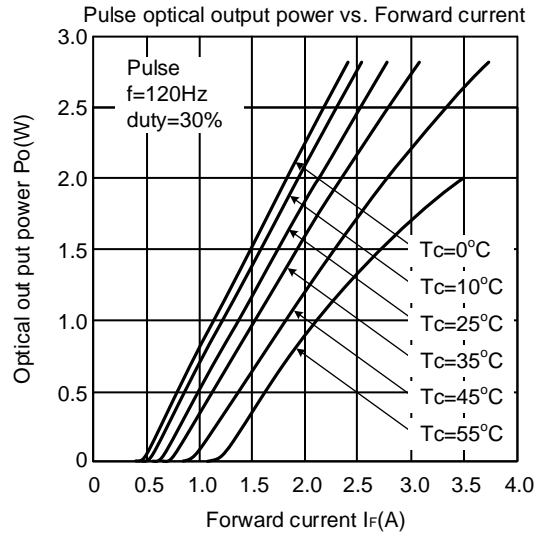
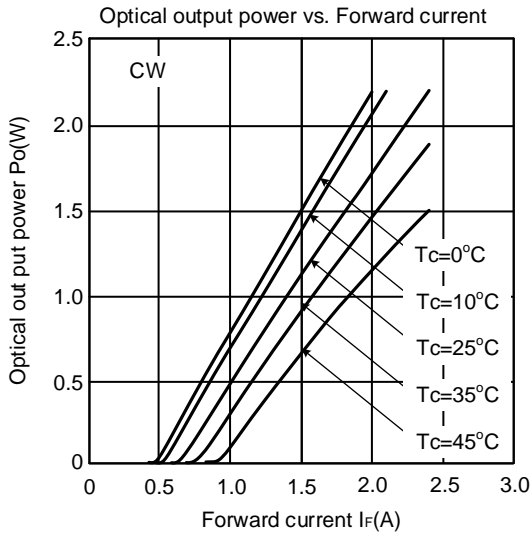

Cautions

1. Ushio Inc. (Ushio) neither warrants nor grants licenses of any our lights or any third party's patent, copyright, trademark, or other intellectual property rights for information contained in this document, Ushio bears no responsibility for problems that may arise with third party's right, including intellectual property rights, in connection with use of the information contained in this document.
2. Products and product specifications may be subject to change without notice. Confirm that you have received the latest product standards or specifications before final design, purchase or use.
3. Ushio makes every attempt to ensure that its products are of high quality and reliability. However, contact our sales office before using the product in an application that demands especially high quality and reliability or where its failure or malfunction may directly threaten human life or cause risk of bodily injury, such as aerospace, aeronautics, nuclear power, combustion control, transportation, traffic safety equipment or medical equipment for life support.
4. Design your application so that the products is used within the ranges guaranteed by Ushio. particularly for maximum rating, operating supply voltage range, heat radiation characteristics, installation conditions and other characteristics. Ushio bears no responsibility for failure or damage when used beyond the guaranteed ranges. Even within the guaranteed ranges, consider normally foreseeable failure rates or failure modes in semiconductor devices and employ systemic measures such as fail-safes, so that the equipment incorporating Ushio product does not cause bodily injury, fire or other consequential damage due to operation of the Ushio product.
5. This product is not designed to be radiation resistant.
6. No one is permitted to reproduce or duplicate, in any form, the whole or part of this document without written approval from Ushio.
7. Contact our sales office for any questions regarding this document or Ushio products.

1. The laser light is harmful to human body especially to eye no matter what directly or indirectly. The laser beam shall be observed or adjusted through infrared camera or equivalent.
2. This product contains gallium arsenide (GaAs) and beryllium oxide (BeO), which may seriously endanger your health even at very low doses. Please avoid treatment which may create powder or gas, such as disassembly or performing chemical experiments, when you handle the product. When disposing of the product, please follow the laws of your country and separate it from other waste such as industrial waste and household garbage.

Important Notice

Performance figures, data and any illustrative material provided in this data sheet are typical and must be specifically confirmed in writing by Ushio before they become applicable to any particular order or contract. In accordance with the Ushio policy of continuous improvement specifications may change without notice. Further details are available from any Ushio sales representative.



Caution - use of controls or adjustments or performance of procedures other than those specified herein may result in hazardous radiation exposure.

Disclaimer

Product specifications and data shown in this product catalog are subject to change without notice for the purposes of improving product performance, reliability, design, or otherwise.

Product data and parameters in this catalog are typical values based on reasonably up-to-date measurements.

Product data and parameters may vary by user application and over time.

Products shown in this catalog are intended to be used for general electronic equipment. Products are not guaranteed for applications where product malfunction or failure may cause personal injury or death, including but not limited to life-supporting / saving devices, medical devices, safety devices, airplanes, aerospace equipment, automobiles, traffic control systems, and nuclear reactor control systems.