



### Features :

- ◆ 445nm wavelength
- ◆ 100W/150W/200W output power
- ◆ 105μm fiber core diameter
- ◆ 0.22NA
- ◆ Cooling mode: water cooling



www.rpmclasers.com

## 445nm Fiber Coupled Blue Laser RPK445-R6-150.0W-10522-SM

### Applications :

- ◆ Material Processing
- ◆ 3D Printing

Specifications(20°C)		Symbol	Unit	RPK445-R6-150.0W-10522-SM		
				Minimum	Typical	Maximum
<b>Optical Data<sup>(1)</sup></b>	Total CW Output Power	$P_{bol}^{(4)}$	W	200	-	-
	Number of submodules	pcs	-	-	4	-
	Submodule CW Output Power	$P_o$	W	-	50	-
	Center Wavelength	$\lambda_c$	nm	445±20		
	Spectral Width (FWHM)	$\Delta\lambda$	nm	-	6	-
	Wavelength Shift with Temperature	$\Delta\lambda/\Delta T$	nm/°C	-	0.1	-
	Wavelength Shift with Current	$\Delta\lambda/\Delta A$	nm/A	-	1	-
<b>Electrical Data</b>	Electrical-to-Optical Efficiency	PE	%	-	30	-
	Operating Current	$I_{bol}^{(4)}$	A	-	3	3.5
	Threshold Current	$I_{th}$	A	-	0.35	-
	Operating Voltage ( single module )	$V_{op}$	V	-	52	60
	Slope Efficiency ( single module )	$\eta$	W/A	-	18.5	-
	Power Supply Mode	-	-	-	4 modules	-
<b>Fiber Data</b>	Core Diameter	$D_{core}$	μm	-	105	-
	Numerical Aperture	NA	-	-	0.22	-
	Minimum Bending Radius	-	mm	50	-	-
	Fiber Length	-	m	-	5.5	-
	Fiber Termination	-	-	-	HP-SMA905	-
<b>Thermistor</b>	-	$R_t$	(KΩ)/β(25°C)	-	10±3%/3450	-
<b>Others</b>	ESD	$V_{esd}$	V	-	-	500
	Storage Temperature <sup>(2)</sup>	$T_{st}$	°C	-20	-	70
	Lead Soldering Temp	$T_{ls}$	°C	-	-	260
	Lead Soldering Time	t	sec	-	-	10
	Operating Temperature <sup>(3)</sup>	$T_{op}$	°C	15	-	30
	Relative Humidity	RH	%	15	-	75

(1) Data measured under operation output at 200W@20°C.

(2) A non-condensing environment is required for operation and storage.

(3) Operating temperature defined by the thermistor. Acceptable operating range is 15°C~30°C, but performance may vary.

(4) Product delivery qualification standards:  $I_{beginning\ of\ life} \leq 3.5A$  ,  $P_{beginning\ of\ life} \geq 200W$ ;

(5) Within the warranty period, the product is considered qualified with  $I_{end\ of\ life} = 3.5A$  ,  $P_{end\ of\ life} \leq 160W$ .

## 445nm Fiber Coupled Blue Laser

### RPK445-R6-150.0W-10522-SM

Specifications(20°C)		Symbol	Unit	RPK445-R6-150.0W-10522-SM		
				Minimum	Typical	Maximum
Optical Data <sup>(1)</sup>	Total CW Output Power	$P_{bol}^{(4)}$	W	150	-	-
	Number of submodules	pcs	-	-	3	-
	Submodule CW Output Power	$P_o$	W	-	50	-
	Center Wavelength	$\lambda_c$	nm	445±20		
	Spectral Width (FWHM)	$\Delta\lambda$	nm	-	6	-
	Wavelength Shift with Temperature	$\Delta\lambda/\Delta T$	nm/°C	-	0.1	-
	Wavelength Shift with Current	$\Delta\lambda/\Delta A$	nm/A	-	1	-
Electrical Data	Electrical-to-Optical Efficiency	PE	%	-	30	-
	Operating Current	$I_{bol}^{(4)}$	A	-	3	3.5
	Threshold Current	$I_{th}$	A	-	0.35	-
	Operating Voltage ( single module )	$V_{op}$	V	-	52	60
	Slope Efficiency ( single module )	$\eta$	W/A	-	18.5	-
	Power Supply Mode	-	-	-	3 modules	-
Fiber Data	Core Diameter	$D_{core}$	μm	-	105	-
	Numerical Aperture	NA	-	-	0.22	-
	Minimum Bending Radius	-	mm	50	-	-
	Fiber Length	-	m	-	5.5	-
	Fiber Termination	-	-	-	HP-SMA905	-
Thermistor	-	$R_t$	(KΩ)/β(25°C)	-	10±3%/3450	-
Others	ESD	$V_{esd}$	V	-	-	500
	Storage Temperature <sup>(2)</sup>	$T_{st}$	°C	-20	-	70
	Lead Soldering Temp	$T_{ls}$	°C	-	-	260
	Lead Soldering Time	t	sec	-	-	10
	Operating Temperature <sup>(3)</sup>	$T_{op}$	°C	15	-	30
	Relative Humidity	RH	%	15	-	75

(1) Data measured under operation output at 150W@20°C.

(2) A non-condensing environment is required for operation and storage.

(3) Operating temperature defined by the thermistor. Acceptable operating range is 15°C~30°C, but performance may vary.

(4) Product delivery qualification standards:  $I_{beginning\ of\ life} \leq 3.5A$  ,  $P_{beginning\ of\ life} \geq 150W$ ;

(5) Within the warranty period, the product is considered qualified with  $I_{end\ of\ life} = 3.5A$  ,  $P_{end\ of\ life} \leq 120W$ .

## 445nm Fiber Coupled Blue Laser

### RPK445-R6-150.0W-10522-SM

Specifications(20°C)		Symbol	Unit	RPK445-R6-150.0W-10522-SM		
				Minimum	Typical	Maximum
Optical Data <sup>(1)</sup>	Total CW Output Power	$P_{bol}^{(4)}$	W	100	-	-
	Number of submodules	pcs	-	-	2	-
	Submodule CW Output Power	$P_o$	W	-	50	-
	Center Wavelength	$\lambda_c$	nm	445±20		
	Spectral Width (FWHM)	$\Delta\lambda$	nm	-	6	-
	Wavelength Shift with Temperature	$\Delta\lambda/\Delta T$	nm/°C	-	0.1	-
	Wavelength Shift with Current	$\Delta\lambda/\Delta A$	nm/A	-	1	-
Electrical Data	Electrical-to-Optical Efficiency	PE	%	-	30	-
	Operating Current	$I_{bol}^{(4)}$	A	-	3	3.5
	Threshold Current	$I_{th}$	A	-	0.35	-
	Operating Voltage ( single module )	$V_{op}$	V	-	52	60
	Slope Efficiency ( single module )	$\eta$	W/A	-	18.5	-
	Power Supply Mode	-	-	-	2 modules	-
Fiber Data	Core Diameter	$D_{core}$	μm	-	105	-
	Numerical Aperture	NA	-	-	0.22	-
	Minimum Bending Radius	-	mm	50	-	-
	Fiber Length	-	m	-	5.5	-
	Fiber Termination	-	-	-	HP-SMA905	-
Thermistor	-	$R_t$	(KΩ)/β(25°C)	-	10±3%/3450	-
Others	ESD	$V_{esd}$	V	-	-	500
	Storage Temperature <sup>(2)</sup>	$T_{st}$	°C	-20	-	70
	Lead Soldering Temp	$T_{ls}$	°C	-	-	260
	Lead Soldering Time	t	sec	-	-	10
	Operating Temperature <sup>(3)</sup>	$T_{op}$	°C	15	-	30
	Relative Humidity	RH	%	15	-	75

(1) Data measured under operation output at 100W@20°C.

(2) A non-condensing environment is required for operation and storage.

(3) Operating temperature defined by the thermistor. Acceptable operating range is 15°C~30°C, but performance may vary.

(4) Product delivery qualification standards:  $I_{beginning\ of\ life} \leq 3.5A$  ,  $P_{beginning\ of\ life} \geq 100W$ ;

(5) Within the warranty period, the product is considered qualified with  $I_{end\ of\ life} = 3.5A$  ,  $P_{end\ of\ life} \leq 80W$ .

**445nm Fiber Coupled Blue Laser**  
**RPK445-R6-150.0W-10522-SM**

**Package Dimensions (mm)**

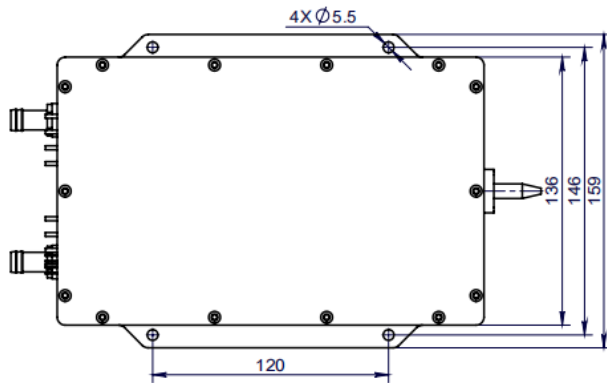
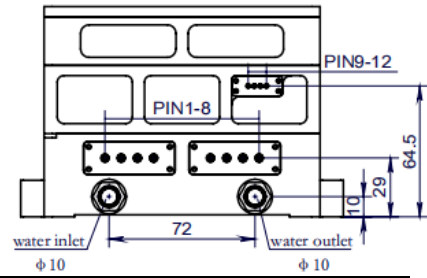
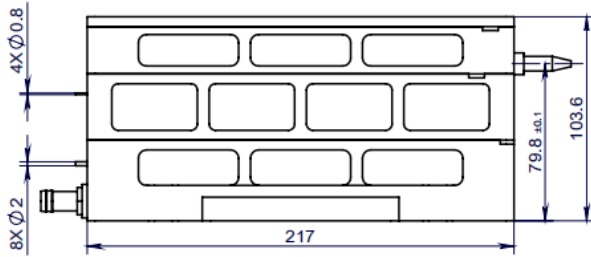

Pin	Function
1	LD1(+)
2	LD1(-)
3	LD2(+)
4	LD2(-)
5	LD3(+)
6	LD3(-)
7	LD4(+)
8	LD4(-)
9	*Thermistor
10	*Thermistor
11	*Aiming Beam+
12	*Aiming Beam-

1. The RPK445HR6FN Series blue laser consists of up to 4 submodules ( 50W per module ) . Power can be supplied separately or in series.
2. The RPK445HR6FN Series blue laser cooling water inlet and outlet size: Outer 10mm\* Inner 6.5mm.The water flow should be at least 5L/min.
3. \*: Optional functions.

## 445nm Fiber Coupled Blue Laser

### RPK445-R6-150.0W-10522-SM

---

#### OPERATING NOTES

- ◆ Avoid eye and skin exposure to direct radiation during operation.
- ◆ ESD precautions must be taken during storage, transportation and operation.
- ◆ Short-circuit is required between pins during storage and transportation.
- ◆ Please connect pins to wires by solder instead of using socket when operation current is higher than 6A. Soldering point should be close to the root of the pins. Soldering temperature should be lower than 260°C and time shorter than 10 second.
- ◆ Make sure the fiber output end is properly cleaned before operation of laser. Follow safety protocols to avoid injury when handling and cutting the fiber.
- ◆ Use constant current power supply to avoid surge current during operation.
- ◆ Laser diode must be used according to the specifications.
- ◆ Laser diode must work with good cooling.
- ◆ Operation temperature ranges from 15°C to 30°C.
- ◆ Storage temperature ranges from -20°C to +70°C.



**Declaration:** information and specifications contained herein are deemed to be reliable and accurate. BWT reserves the right to change, alter or modify the design and specifications of these products at any time without notice.22-02.