

SemiNex delivers the highest available power at infrared wavelengths between 12xx and 19xx nm. When necessary we will further optimize the design of our InP laser chips to meet our customers' specific optical and electrical performance needs. Diodes, bars and packages are tested to meet customer and market performance demands. Typical results and packaging options are shown. Contact SemiNex for additional details or to discuss your specific requirements.



## TO-9 Packaged Laser Diode

High Power Single-Mode and Multi-Mode SemiNex Lasers  
 12xx to 19xx nm  
 Custom Wavelengths Available  
 Lensed Options Available

### Applications

- OEM Medical
- Professional Medical
- LiDAR
- Military / Aerospace
- Illumination

### Features

- Cost effective
- High Output Power
- High Dynamic Range
- High Efficiency
- Standard Low Cost Package

TO9: 95  $\mu\text{m}$  Emitter 2.5 mm CL, Uncapped

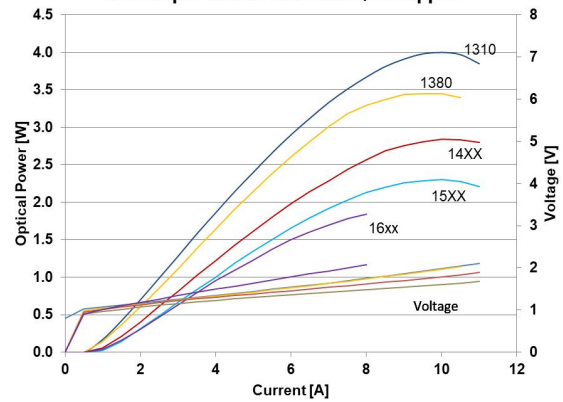



	Symbol	TO9-121	Units
<b>Optical</b>			
Wavelength	$\lambda_c$	1465	nm ( $\pm 20$ )
Output Power (CW)	$P_o$	1.80	watts ( $\pm 10\%$ )
Chip Cavity Length	CL	2500	$\mu\text{m}$
Emitter Width	W	95	$\mu\text{m}$
Emitter Height	H	1	$\mu\text{m}$
Spectral Width	$\delta\lambda$	10	nm 3dB
Slope Efficiency	$\eta_s$	0.30	W/A
Fast Axis Div.*	$\Theta_{\text{perp}}$	28	deg FWHM
Slow Axis Div.	$\Theta_{\text{parallel}}$	9	deg FWHM
<b>Electrical</b>			
Power Conversion Eff.	$\eta$	13	%
Operating Current	$I_{\text{op}}$	6	A
Threshold Current	$I_{\text{th}}$	0.5	A
Operating Voltage	$V_{\text{op}}$	1.7	V
<b>Mechanical</b>			
Weight		1.5	g
Operating Temp.**		-40 to 60	$^{\circ}\text{C}$
Storage Temp.		-40 to 80	$^{\circ}\text{C}$

Specified values are rated at a constant heat sink temperature of 20°C.  
 \*\*Specified operating conditions are based on 20°C heat sink temperature. High temperature operation will reduce performance and MTTF. Unless otherwise indicated all values are nominal.  
 Uncapped TO9 specifications assume heatsinking underneath laser chip.  
 Capped TO9 specifications assume heatsinking only on flat surface where pins extend.

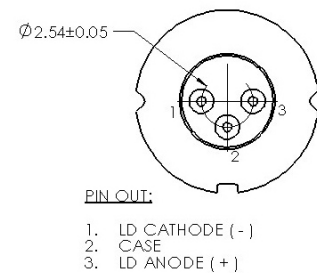
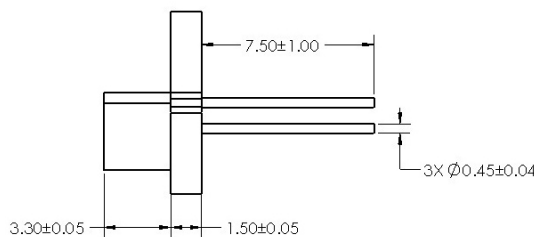
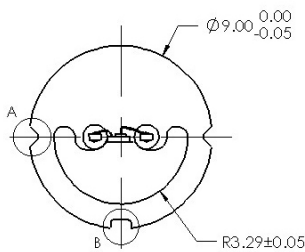
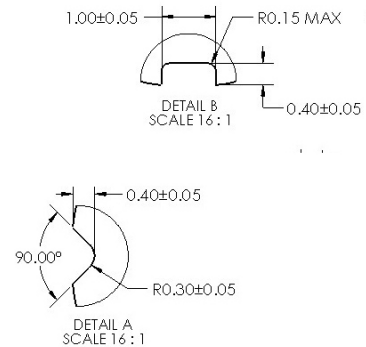
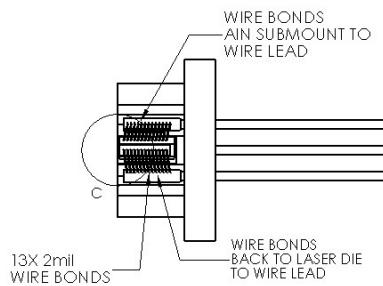
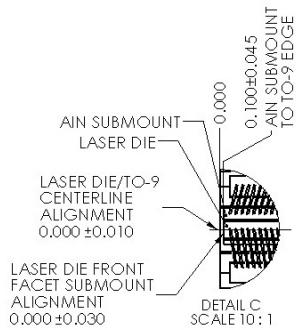

All statements, technical information and recommendations related to the product herein are based upon information believed to be reliable or accurate. The accuracy or completeness herein is not guaranteed, and no responsibility is assumed for any inaccuracies. The user assumes all risks and liability whatsoever in connection with the use of a product or its application. SemiNex Corporation reserves the right to change at any time without notice the design, specification, deduction, fit or form of its described herein, including withdrawal at any time of a product offered for sale herein. Users are encouraged to visit [www.seminex.com](http://www.seminex.com) for the latest data. SemiNex Corporation makes no representations that the products herein are free from any intellectual property claims of others. Please contact SemiNex for more information. © 2016 SemiNex Corporation

SemiNex Corporation • 153 Andover St • Danvers, MA 01923 • 978-326-7700 • Email: [info@seminex.com](mailto:info@seminex.com) • [www.seminex.com](http://www.seminex.com)

Date Created: Jun 27 2023 8:45PM UTC

