

SemiNex delivers the highest available power at infrared wavelengths between 12xx and 19xx nm. When necessary we will further optimize the design of our InP laser chips to meet our customers' specific optical and electrical performance needs. Diodes, bars and packages are tested to meet customer and market performance demands. Typical results and packaging options are shown. Contact SemiNex for additional details or to discuss your specific requirements.



C-Mount

High Power Single-Mode and Multi-Mode SemiNex Lasers
 12xx to 19xx nm
 Custom Wavelengths Available
 Lensed Options Available

Applications

- OEM Medical
- DPSS pump source
- LiDAR
- Military / Aerospace

Features

- Cost effective
- High Output Power
- High Dynamic Range
- High Efficiency
- Standard Low Cost Package

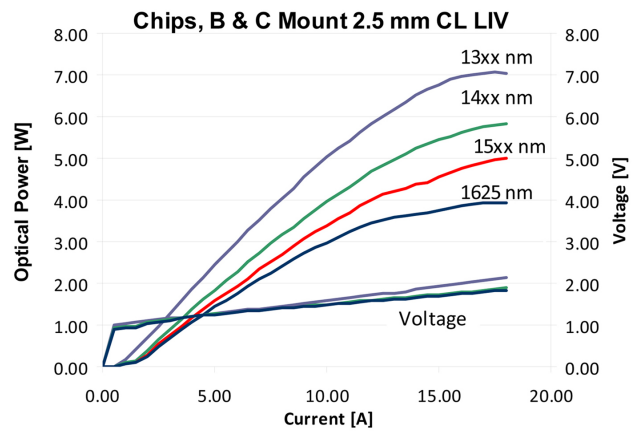



C-Mount



	Symbol	C-128	Units
Optical			
Wavelength	λ_c	1460	nm (± 20)
Output Power (CW)	P_o	5.00	watts ($\pm 10\%$)
Chip Cavity Length	CL	2500	μm
Emitter Width	W	95	μm
Emitter Height	H	1	μm
Spectral Width	$\delta\lambda$	15	nm 3dB
Slope Efficiency	η_s	0.40	W/A
Fast Axis Div.*	Θ_{perp}	28	deg FWHM
Slow Axis Div.	Θ_{parallel}	9	deg FWHM
Electrical			
Power Conversion Eff.	η	21	%
Threshold Current	I_{th}	0.45	A
Operating Current	I_{op}	14	A
Operating Voltage	V_{op}	1.7	V
Mechanical			
Weight		1.3	g
Operating Temp.**		-40 to 60	$^{\circ}\text{C}$
Storage Temp.		-40 to 80	$^{\circ}\text{C}$

Specified values are rated at a constant heat sink temperature of 20°C.
 **Specified operating conditions are based on 20C heat sink temperature. High temperature operation will reduce performance and MTTF.
 Unless otherwise indicated all values are nominal.
 *Fast Axis Divergence can be changed with lens option.

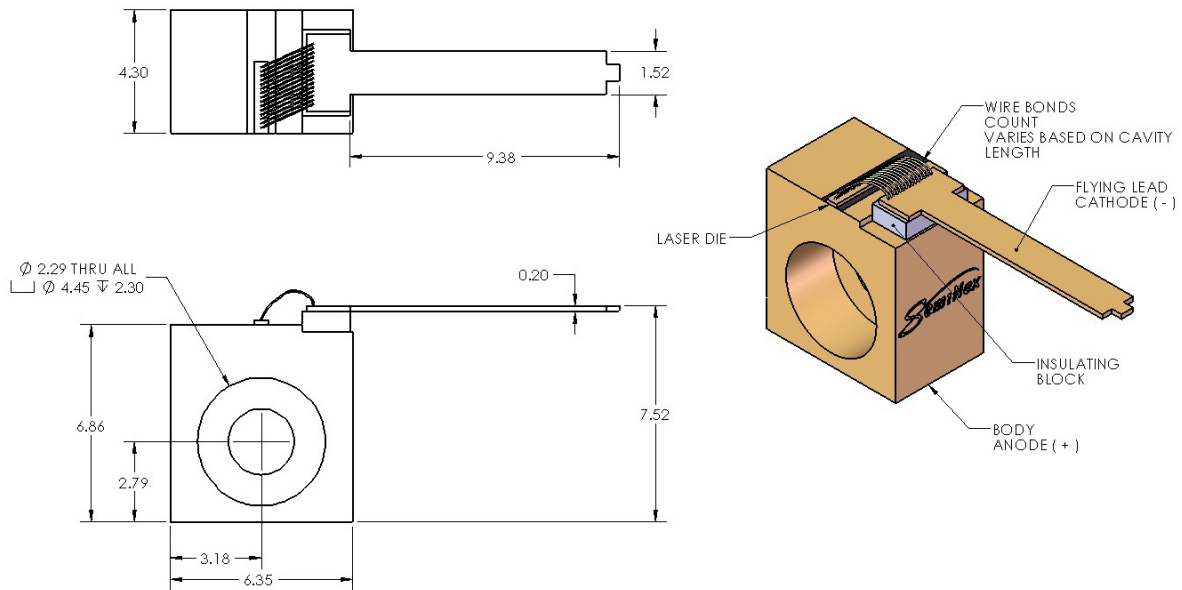

All statements, technical information and recommendations related to the product herein are based upon information believed to be reliable or accurate. The accuracy or completeness herein is not guaranteed, and no responsibility is assumed for any inaccuracies. The user assumes all risks and liability whatsoever in connection with the use of a product or its application. SemiNex Corporation reserves the right to change at any time without notice the design, specification, deduction, fit or form of its described herein, including withdrawal at any time of a product offered for sale herein. Users are encouraged to visit www.seminex.com for the latest data. SemiNex Corporation makes no representations that the products herein are free from any intellectual property claims of others. Please contact SemiNex for more information. © 2016 SemiNex Corporation

SemiNex Corporation • 153 Andover St • Danvers, MA 01923 • 978-326-7700 • Email: info@seminex.com • www.seminex.com

Date Created: Nov 30 2023 10:18PM UTC

